

Print all 4 pages at 100%. Trim page 1 and 2 to the purple lines and tape together to match up the crown piece. Cut out the pieces on page 3 and 4 and tape them together along the short narrow side. To pick the pattern size you want compare the headpiece to your head across the top ear to ear. Pick the color line that reaches the bottoms of your ears on both sides. Trim the crown piece to the same color line.

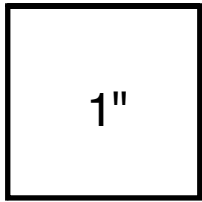

1cm

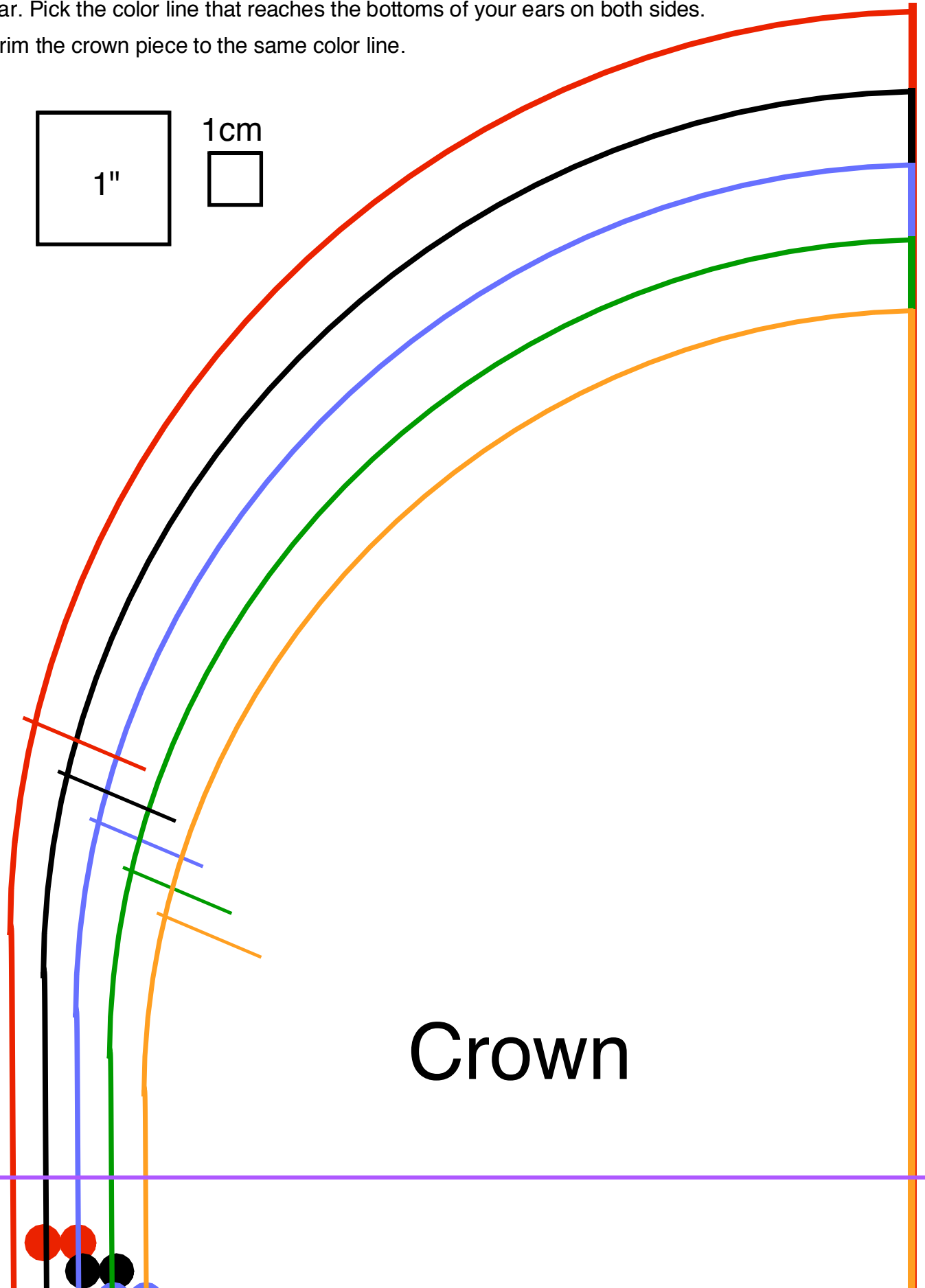

Crown

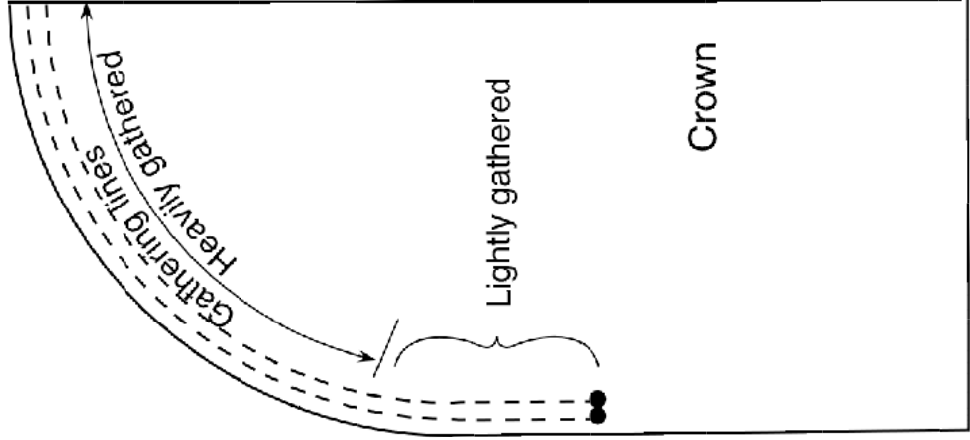
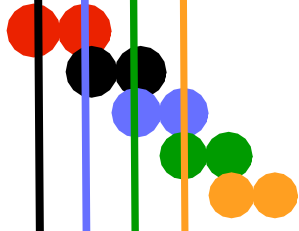

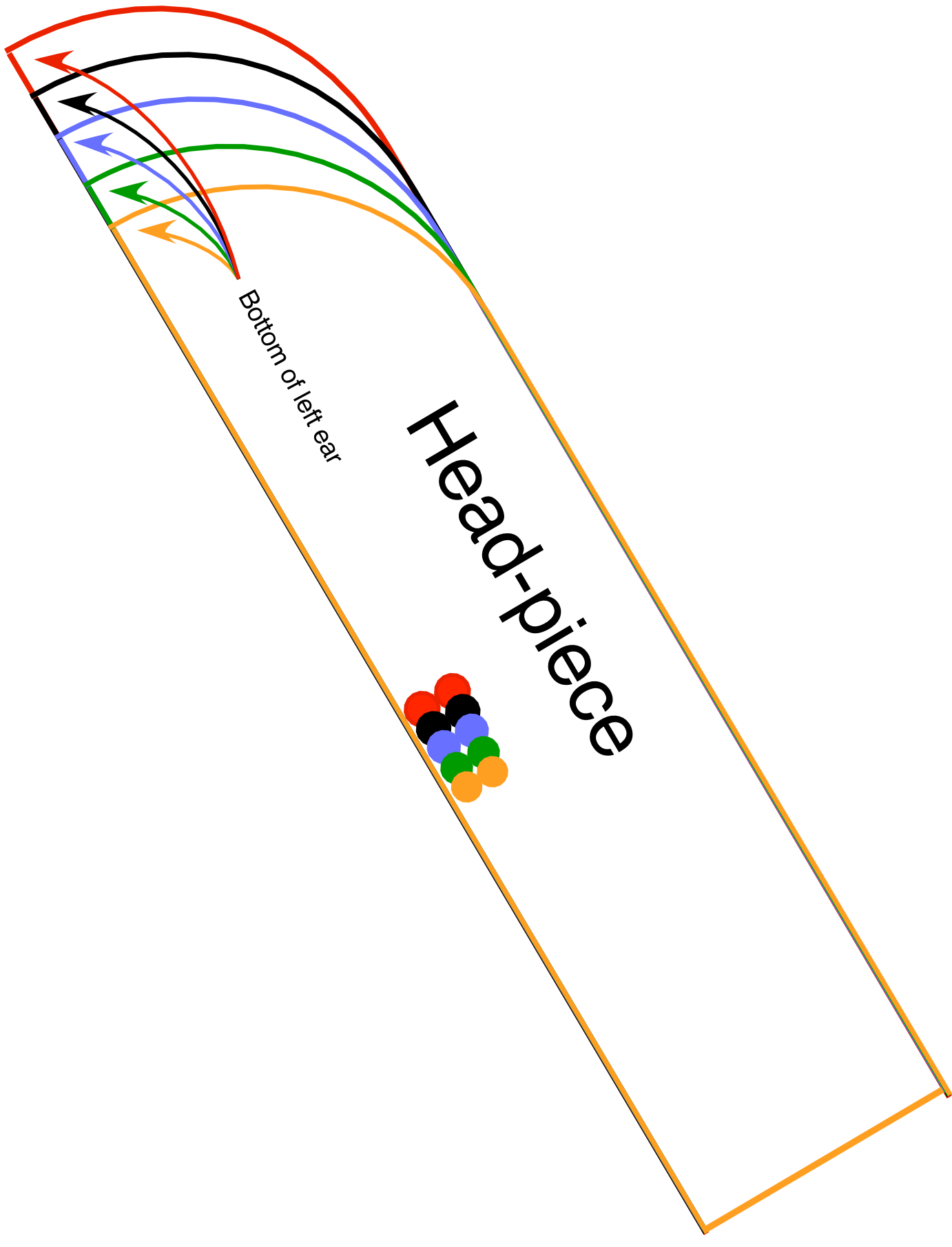

Bottom of left ear

Head-piece

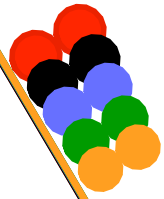





“Let you paper be 4 nails w

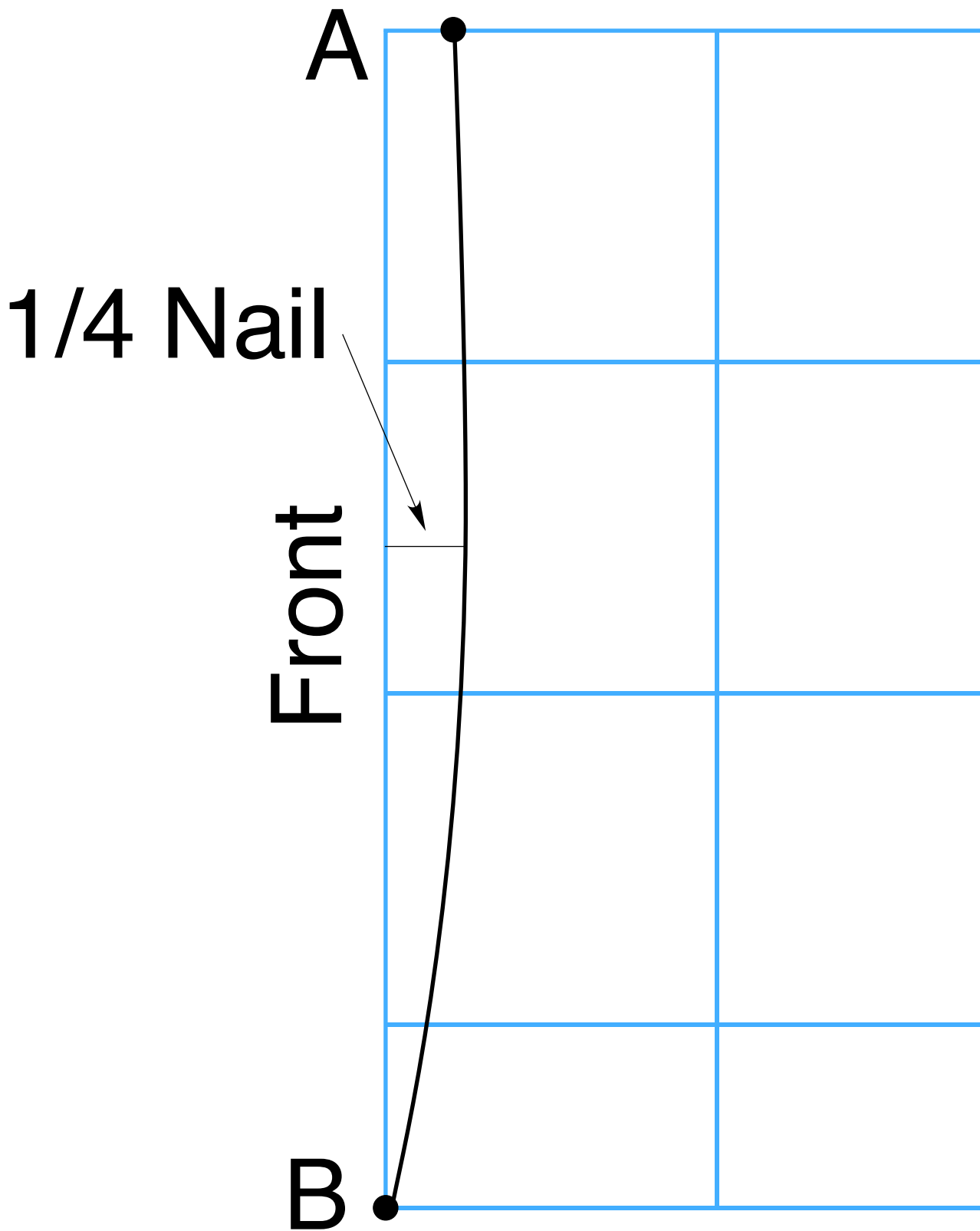

“The front, A B, is a little ho

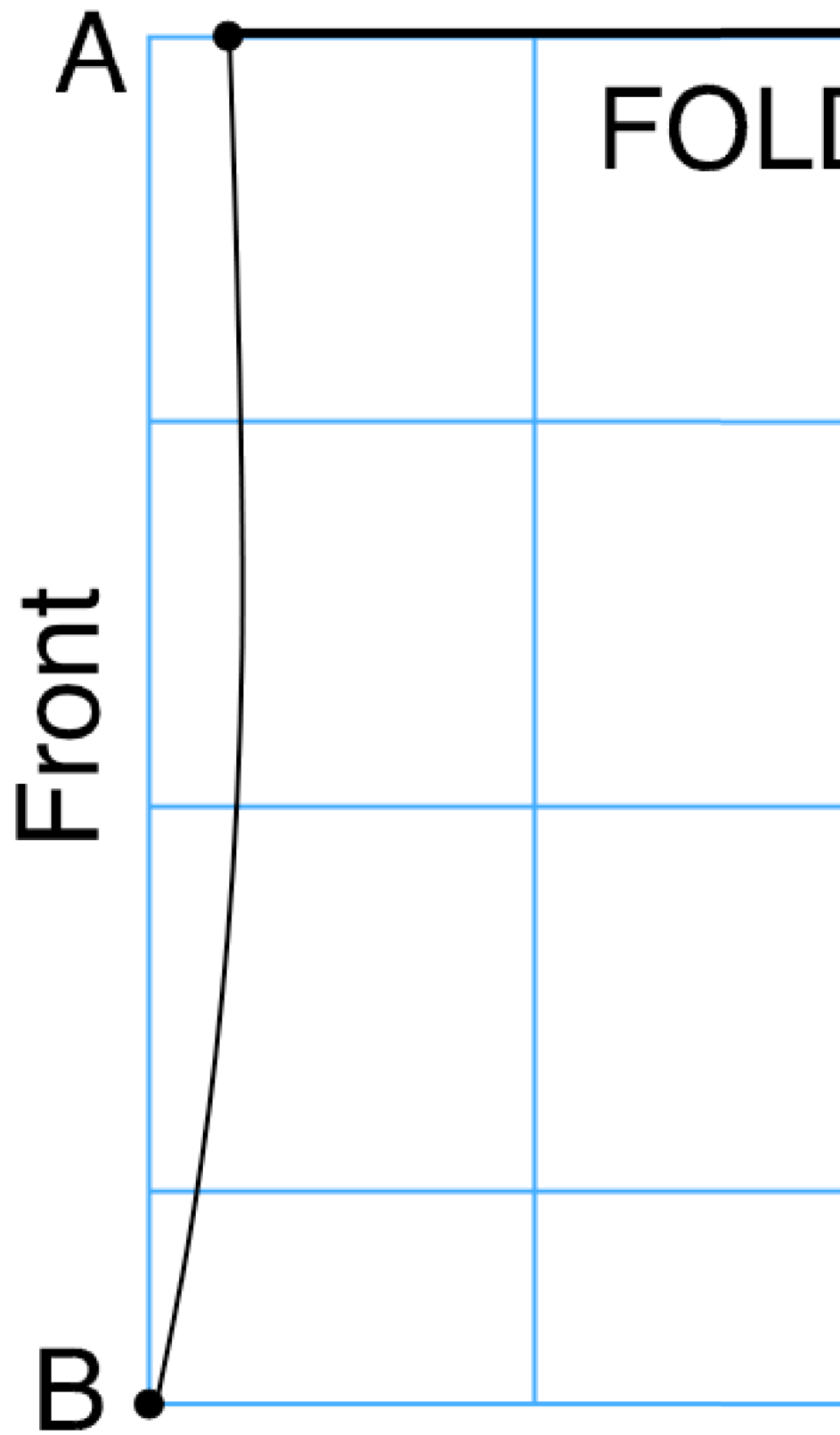

"D is

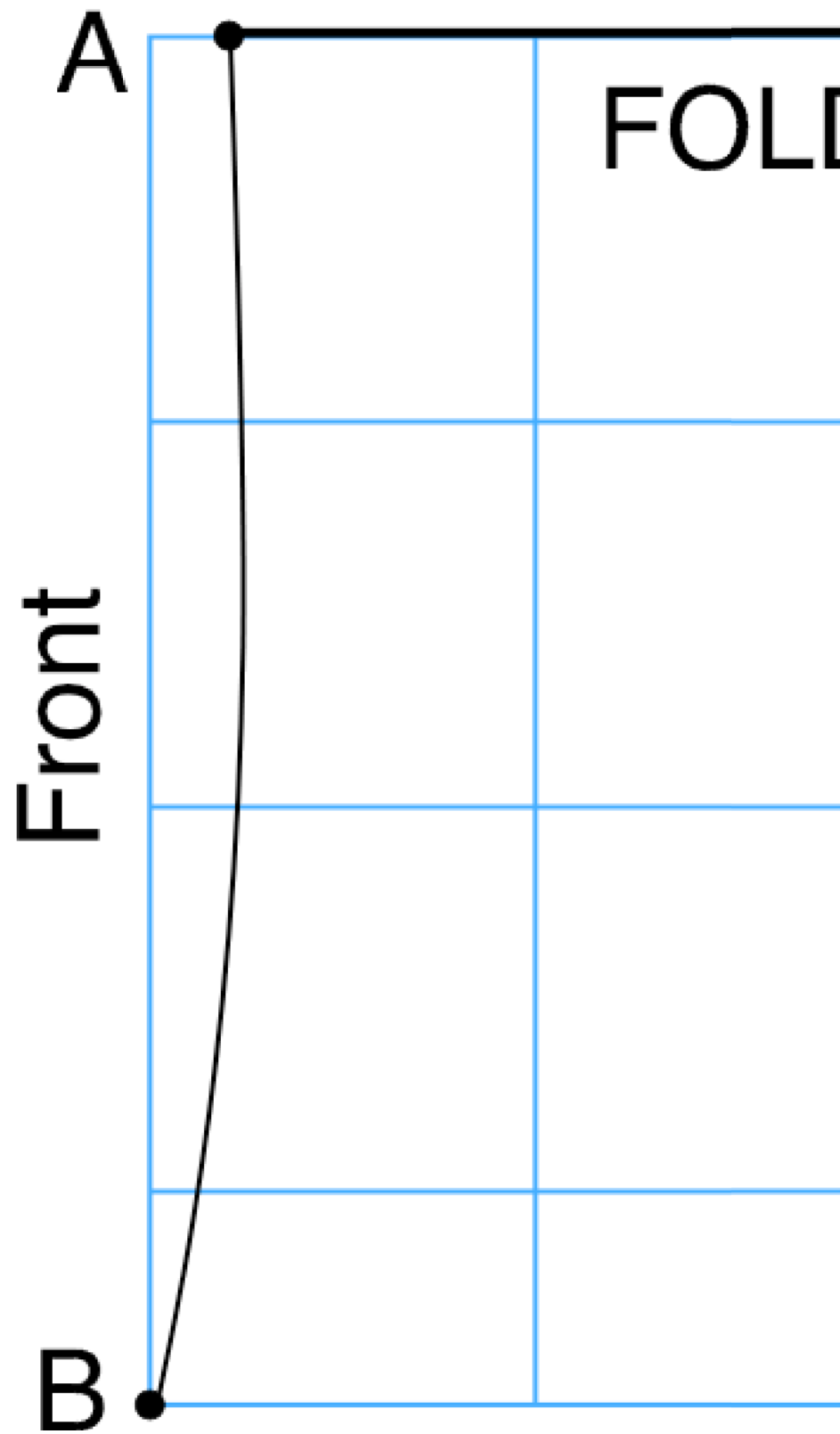

*"E is two nails and a half from
from*

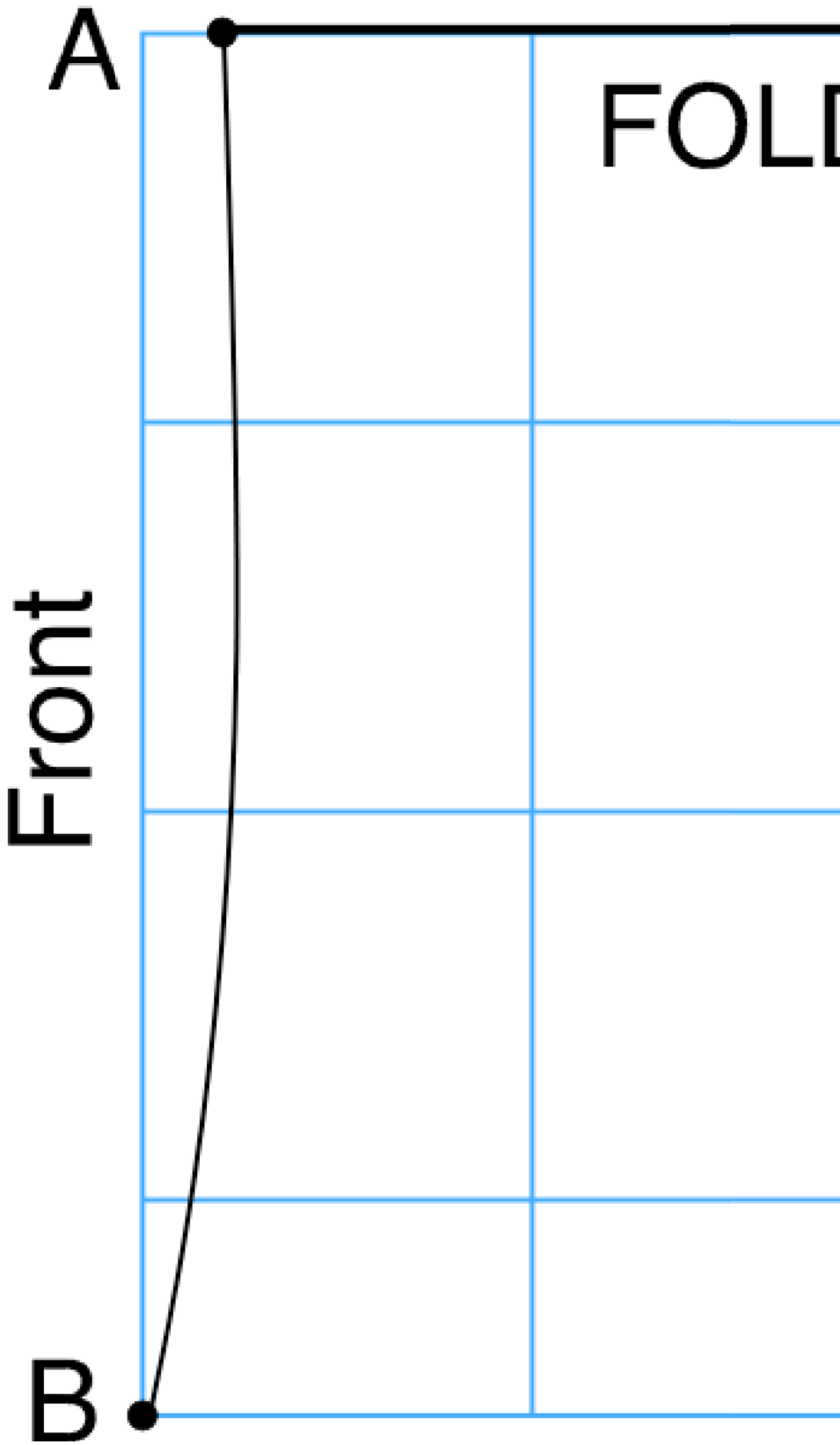

"Slope"

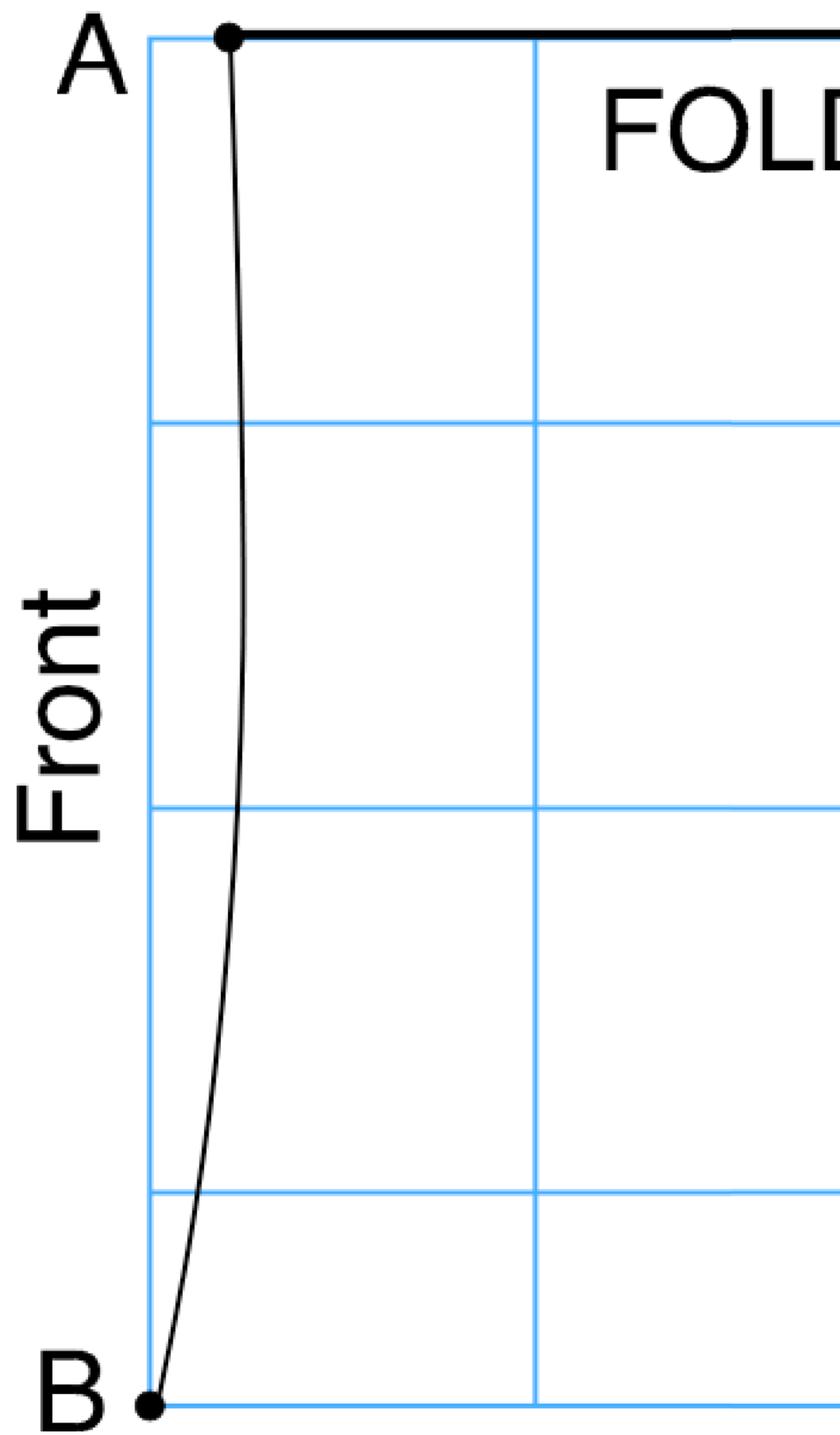

*and from E to C, which is one
quarter of a na*

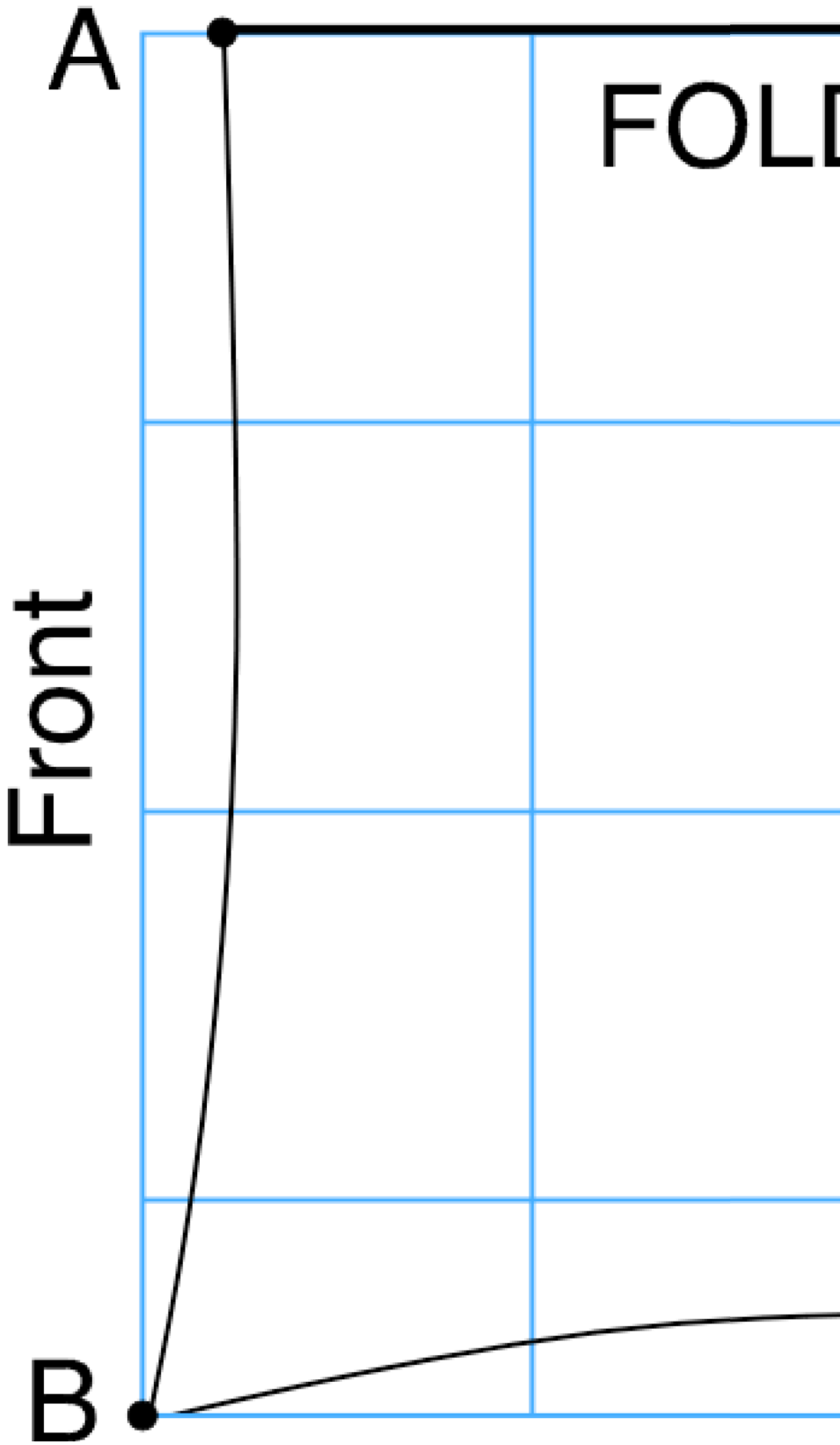

"Curve a

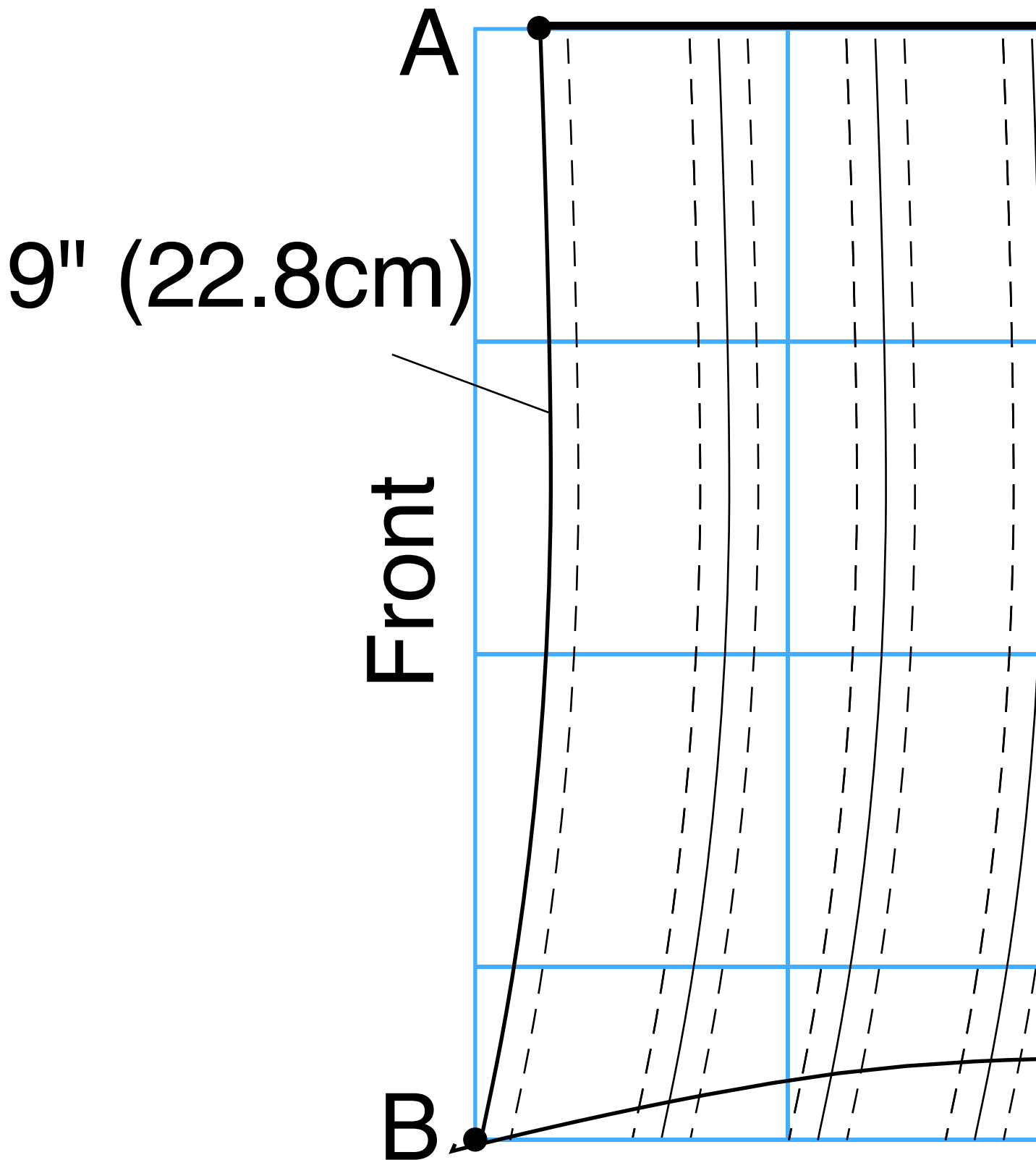

Add any extra notations such as (ribbon channels). M

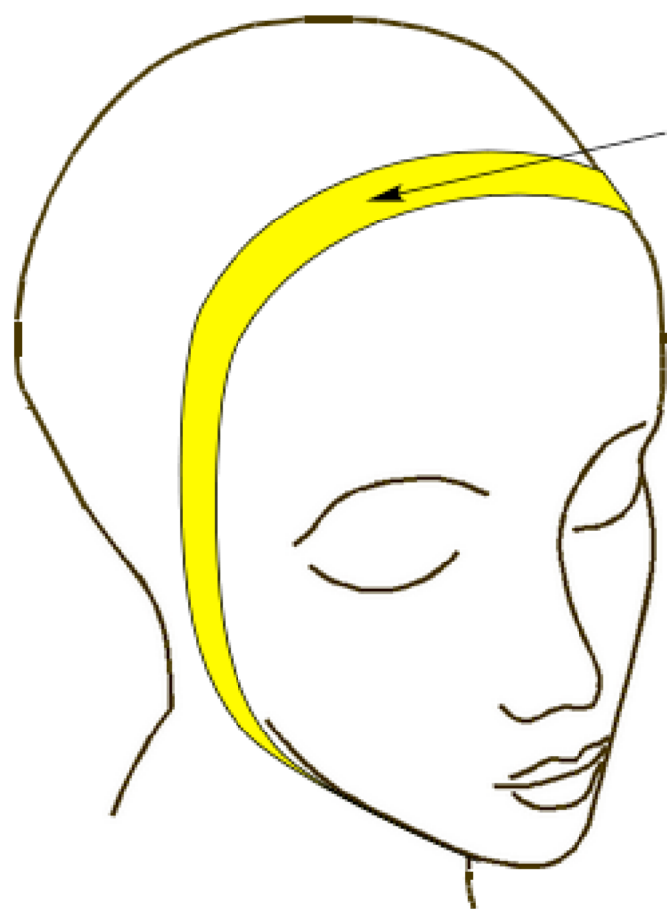

distance
around the top
of the head to
under the chin
20" (50.8cm)

